

# HUR2x30-40

Soft Recovery Behaviour High-Performance Wide Temperature Range Ultra Fast Recovery Epitaxial Diodes

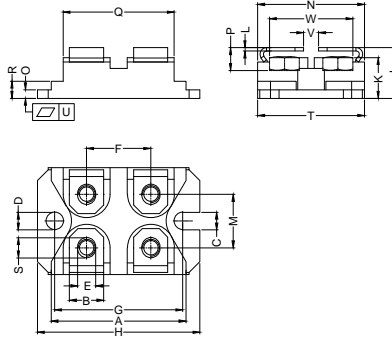

Dimensions SOT -227



Dim.	Millimeter		Dim.	Millimeter	
	Min.	Max.		Min.	Max.
A	31.30	31.65	M	12.00	13.00
B	7.80	8.40	N	25.15	25.65
C	4.00	4.30	O	1.95	2.15
D	∅4.00	∅4.30	P	5.60	6.60
E	4.00	4.30	Q	25.30	26.30
F	14.90	15.20	R	3.90	4.30
G	30.10	30.30	S	4.45	4.85
H	38.00	38.50	T	24.50	25.10
J	12.10	12.90	U	0.05	0.10
K	9.00	9.60	V	3.00	4.80
L	0.75	0.85	W	19.30	20.50

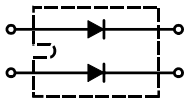

	$V_{RSM}$ V	$V_{RRM}$ V
<b>HUR2x30-40</b>	400	400

Symbol	Test Conditions	Maximum Ratings	Unit
$I_{FRMS}$ $I_{FAVM}$	$T_C=105^{\circ}C$ ; rectangular, $d=0.5$	100 30	A
$I_{FSM}$	$T_{VJ}=45^{\circ}C$ ; $t_p=10ms$ (50Hz), sine	tbd	A
$E_{AS}$	$T_{VJ}=25^{\circ}C$ ; non-repetitive; $I_{AS}=tbdA$ ; $L=tbd\mu H$	tbd	mJ
$I_{AR}$	$V_A=1.5 \cdot V_R$ typ.; $f=10kHz$ ; repetitive	tbd	A
$T_{VJ}$ $T_{VJM}$ $T_{stg}$		-40...+150 150 -40...+150	$^{\circ}C$
$P_{tot}$	$T_C=25^{\circ}C$	100	W
$V_{ISOL}$	50/60Hz, RMS $I_{ISOL} \leq 1mA$	2500	V~
$M_d$	mounting torque (M4) terminal connection torque (M4)	1.1-1.5/9-13 1.1-1.5/9-13	Nm/lb.in.
Weight	typical	30	g

# HUR2x30-40

Soft Recovery Behaviour High-Performance Wide Temperature Range Ultra Fast Recovery Epitaxial Diodes

Symbol	Test Conditions	Characteristic Values		Unit
		typ.	max.	
$I_R$	$T_{VJ}=25^{\circ}\text{C}; V_R=V_{RRM}$ $T_{VJ}=150^{\circ}\text{C}; V_R=V_{RRM}$		0.25 1	mA
$V_F$	$I_F=30\text{A}; T_{VJ}=125^{\circ}\text{C}$ $T_{VJ}=25^{\circ}\text{C}$		1.15 1.45	V
$R_{thJC}$ $R_{thCH}$		0.1	1.15	K/W
$t_{rr}$	$I_F=1\text{A}; -di/dt=200\text{A}/\mu\text{s}; V_R=30\text{V}; T_{VJ}=25^{\circ}\text{C}$	30		ns
$I_{RM}$	$V_R=100\text{V}; I_F=50\text{A}; -di_F/dt=100\text{A}/\mu\text{s}; T_{VJ}=100^{\circ}\text{C}$		6.8	A

## FEATURES

- \* International standard package miniBLOC
- \* Isolation voltage 2500 V~
- \* 2 independent FRED in 1 package
- \* Glass passivated chips
- \* Very short recovery time
- \* Extremely low switching losses
- \* Low  $I_{RM}$ -values
- \* Soft recovery behaviour
- \* UL File NO.E310749
- \* RoHS compliance

## APPLICATIONS

- \* Antiparallel diode for high frequency switching devices
- \* Antisaturation diode
- \* Snubber diode
- \* Free wheeling diode in converters and motor control circuits
- \* Rectifiers in switch mode power supplies (SMPS)
- \* Inductive heating
- \* Uninterruptible power supplies (UPS)
- \* Ultrasonic cleaners and welders

## ADVANTAGES

- \* Avalanche voltage rated for reliable operation
- \* Soft reverse recovery for low EMI/RFI
- \* Low  $I_{RM}$  reduces:
  - Power dissipation within the diode
  - Turn-on loss in the commutating switch

## ORDERING INFORMATION

Part Number	Package	Shipping	Marking Code
HUR2x30-40	SOT-227	10pcs / Tube	HUR2x30-40

# HUR2x30-40

Soft Recovery Behaviour High-Performance Wide Temperature Range Ultra Fast Recovery Epitaxial Diodes

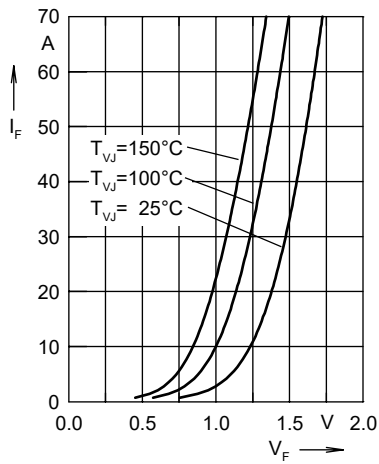

Fig. 1 Forward current  $I_F$  versus  $V_F$

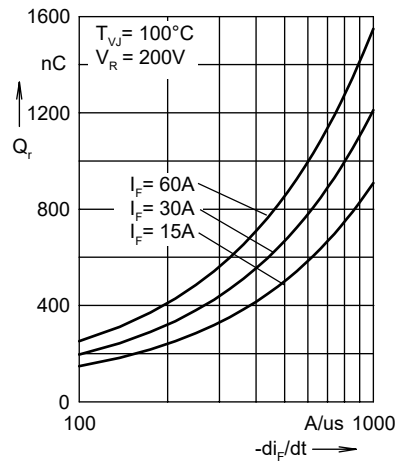

Fig. 2 Reverse recovery charge  $Q_r$  versus  $-di_F/dt$

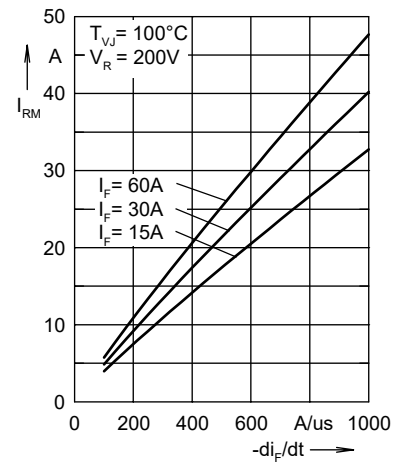

Fig. 3 Peak reverse current  $I_{RM}$  versus  $-di_F/dt$

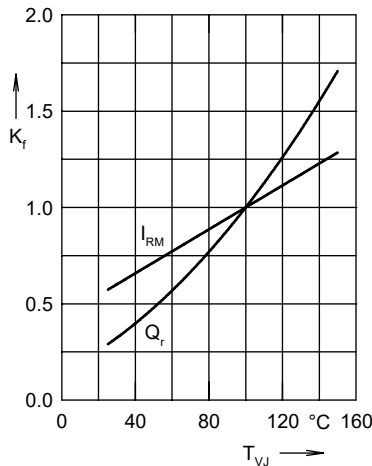

Fig. 4 Dynamic parameters  $Q_r$ ,  $I_{RM}$  versus  $T_{VJ}$

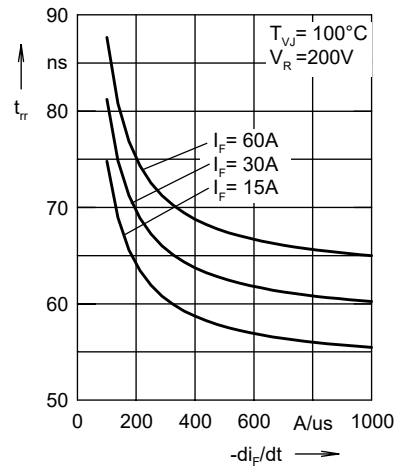

Fig. 5 Recovery time  $t_{tr}$  versus  $-di_F/dt$

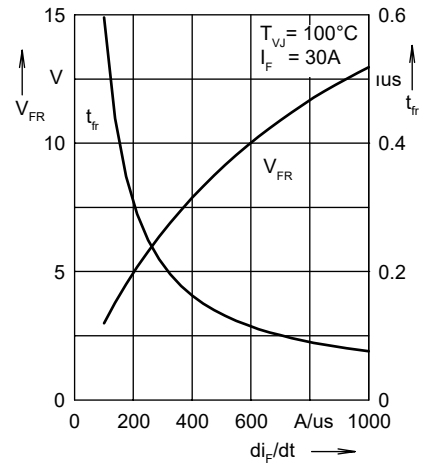

Fig. 6 Peak forward voltage  $V_{FR}$  and  $t_{tr}$  versus  $di_F/dt$

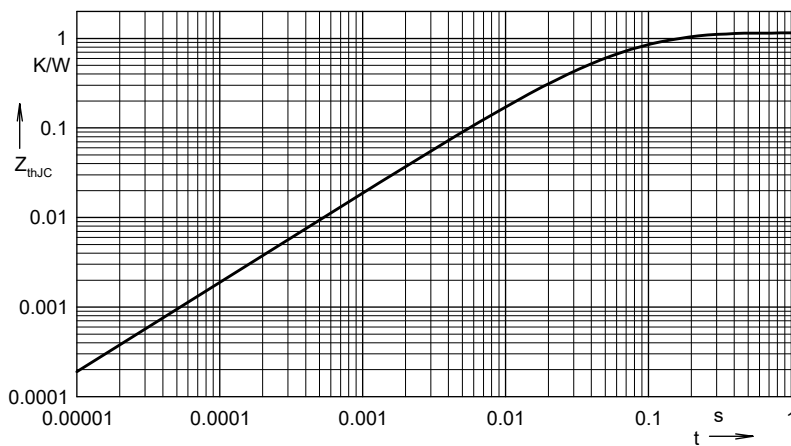

Fig. 7 Transient thermal resistance junction to case

Constants for  $Z_{thJC}$  calculation:

i	$R_{thi}$ (K/W)	$t_i$ (s)
1	0.436	0.0055
2	0.482	0.0092
3	0.117	0.0007
4	0.115	0.0418