

MUR1560S

Ultra Fast Recovery Diodes

C(TAB)



A=Anode, NC= No connection, TAB=Cathode

Dimensions TO-263(D²PAK)

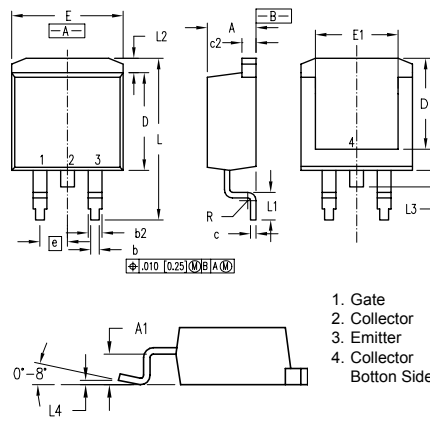

Dim.	Millimeter		Inches	
	Min.	Max.	Min.	Max.
A	4.06	4.83	.160	.190
A1	2.03	2.79	.080	.110
b	0.51	0.99	.020	.039
b2	1.14	1.40	.045	.055
c	0.46	0.74	.018	.029
c2	1.14	1.40	.045	.055
D	8.64	9.65	.340	.380
D1	8.00	8.89	.315	.350
E	9.65	10.29	.380	.405
E1	6.22	8.13	.245	.320
e	2.54 BSC		.100 BSC	
L	14.61	15.88	.575	.625
L1	2.29	2.79	.090	.110
L2	1.02	1.40	.040	.055
L3	1.27	1.78	.050	.070
L4	0	0.20	0	.008
R	0.46	0.74	.018	.029

	V _{RSM}	V _{RRM}
	V	V
MUR1560S	600	600

Symbol	Test Conditions	Maximum Ratings	Unit
I_{FRMS}	T _{VJ} =T _{VJM}	25	A
I_{FAVM}	T _C =100°C; rectangular, d=0.5	15	
I_{FRM}	t _p <10us; rep. rating, pulse width limited by T _{VJM}	150	
I_{FSM}	T _{VJ} =45°C	t=10ms (50Hz), sine t=8.3ms (60Hz), sine	A
	T _{VJ} =150°C	t=10ms(50Hz), sine t=8.3ms(60Hz), sine	
I²t	T _{VJ} =45°C	t=10ms (50Hz), sine t=8.3ms (60Hz), sine	A ² s
	T _{VJ} =150°C	t=10ms(50Hz), sine t=8.3ms(60Hz), sine	
T_{VJ} T_{VJM} T_{stg}		-40...+150 150 -40...+150	°C
P_{tot}	T _C =25°C	62	W
M_d	Mounting torque	0.4...0.6	Nm
Weight		2	g



MUR1560S

Ultra Fast Recovery Diodes

Symbol	Test Conditions	Characteristic Values		Unit
		typ.	max.	
I_R	$T_{VJ}=25^{\circ}\text{C}; V_R=V_{RRM}$		50	uA
	$T_{VJ}=25^{\circ}\text{C}; V_R=0.8 \cdot V_{RRM}$		25	uA
	$T_{VJ}=125^{\circ}\text{C}; V_R=0.8 \cdot V_{RRM}$		3	mA
V_F	$I_F=15\text{A}; T_{VJ}=150^{\circ}\text{C}$		1.5	V
	$T_{VJ}=25^{\circ}\text{C}$		1.7	
V_{TO}	For power-loss calculations only		1.12	V
r_T	$T_{VJ}=T_{VJM}$		23.2	mΩ
R_{thJC} R_{thCK} R_{thJA}		0.5	2	K/W
			60	
t_{rr}	$I_F=1\text{A}; -di/dt=50\text{A}/\mu\text{s}; V_R=30\text{V}; T_{VJ}=25^{\circ}\text{C}$	35	50	ns
I_{RM}	$V_R=350\text{V}; I_F=15\text{A}; -di_F/dt=100\text{A}/\mu\text{s}; L \leq 0.05\mu\text{H}; T_{VJ}=100^{\circ}\text{C}$	4	4.4	A

FEATURES

- * International standard package JEDEC TO-263
- * Glass passivated chips
- * Very short recovery time
- * Extremely low switching losses
- * Low I_{RM}-values
- * Soft recovery behaviour
- * RoHS compliant

APPLICATIONS

- * Antiparallel diode for high frequency switching devices
- * Antisaturation diode
- * Snubber diode
- * Free wheeling diode in converters and motor control circuits
- * Rectifiers in switch mode power supplies (SMPS)
- * Inductive heating and melting
- * Uninterruptible power supplies (UPS)
- * Ultrasonic cleaners and welders

ADVANTAGES

- * High reliability circuit operation
- * Low voltage peaks for reduced protection circuits
- * Low noise switching
- * Low losses
- * Operating at lower temperature or space saving by reduced cooling



MUR1560S

Ultra Fast Recovery Diodes

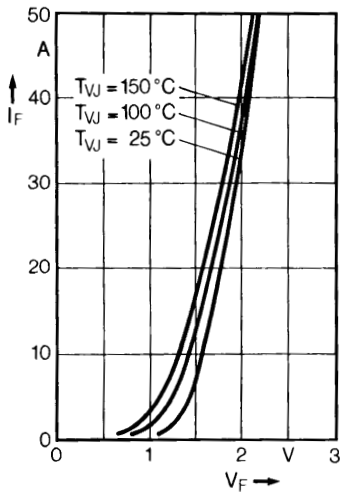

Fig. 1 Forward current versus voltage drop.

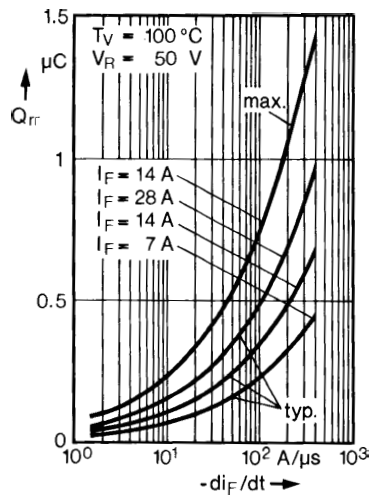

Fig. 2 Recovery charge versus $-di_F/dt$.

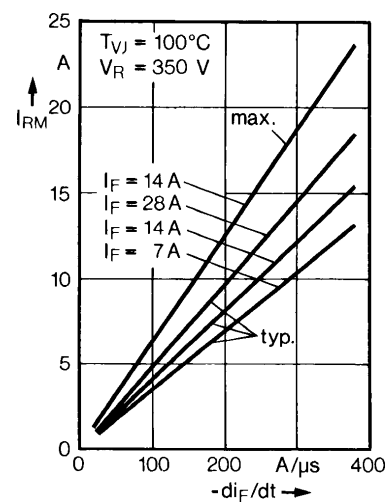

Fig. 3 Peak reverse current versus $-di_F/dt$.

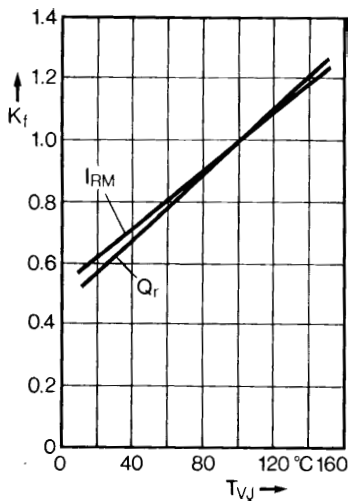

Fig. 4 Dynamic parameters versus junction temperature.

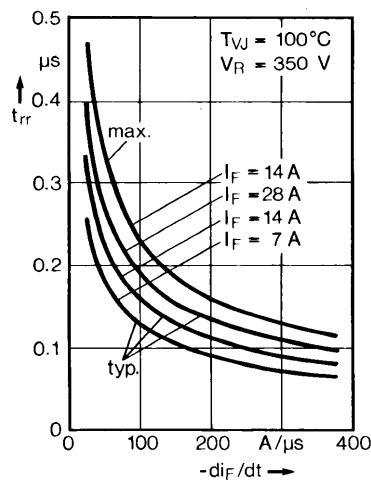

Fig. 5 Recovery time versus $-di_F/dt$.

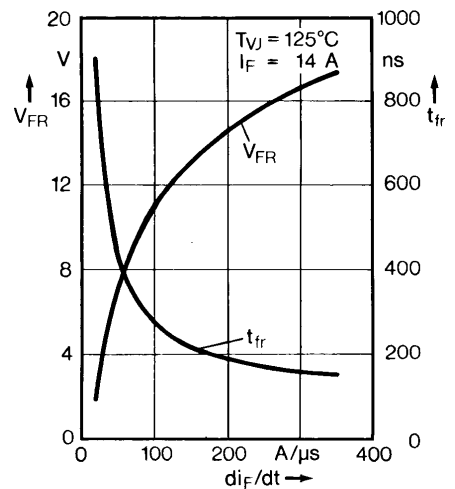

Fig. 6 Peak forward voltage versus di_F/dt .

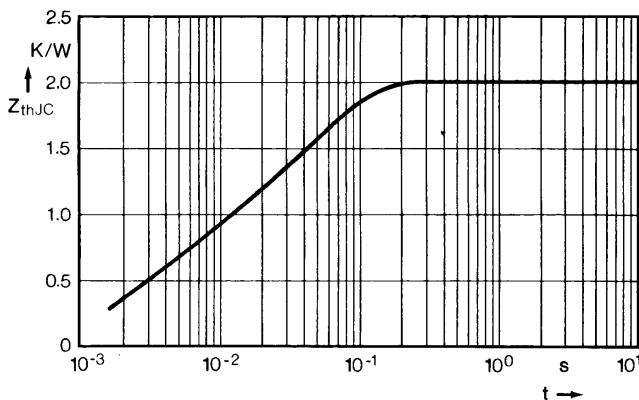

Fig. 7 Transient thermal impedance junction to case.

Sirectifier®